

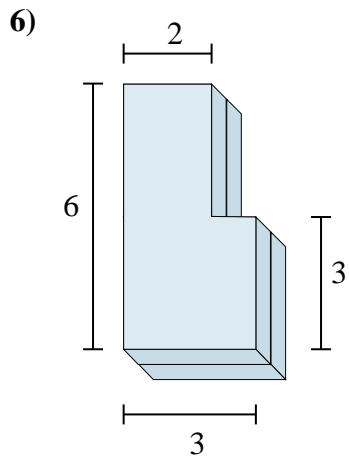

Find the total volume of each figure shown. Measured in cm (not to scale).

Answers

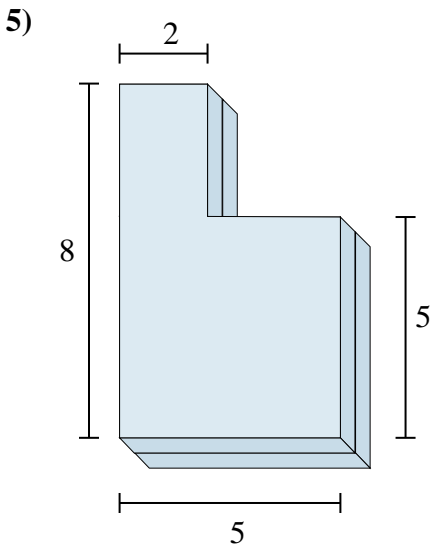
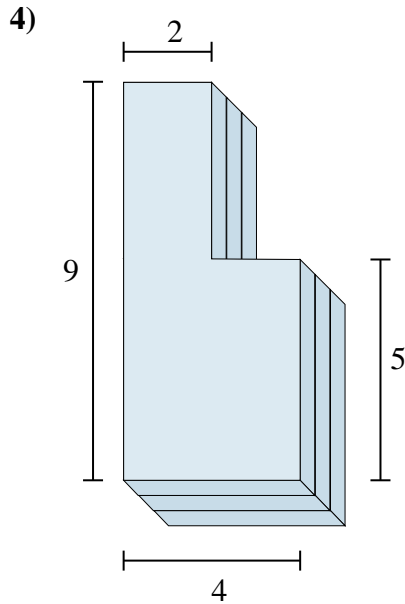
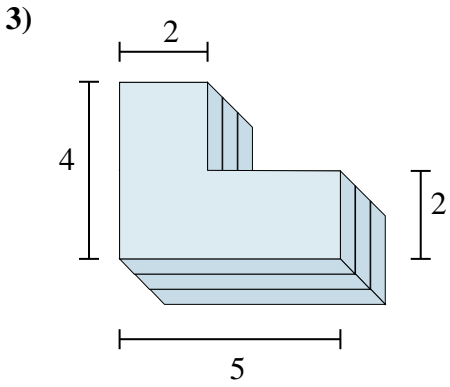
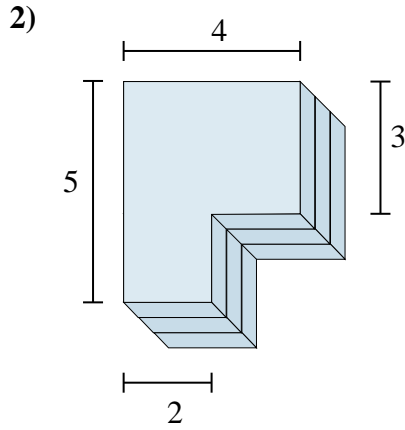
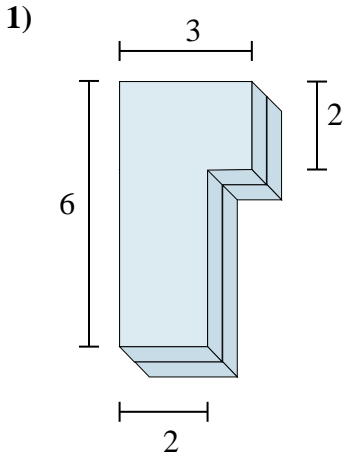

1. \_\_\_\_\_
2. \_\_\_\_\_
3. \_\_\_\_\_
4. \_\_\_\_\_
5. \_\_\_\_\_
6. \_\_\_\_\_



Find the total volume of each figure shown. Measured in cm (not to scale).

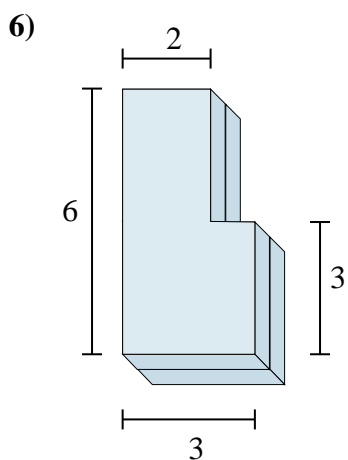
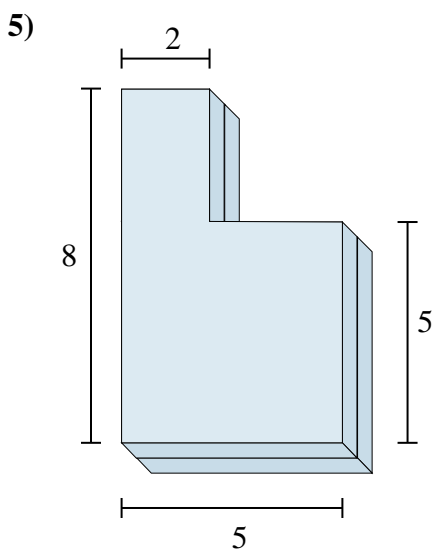
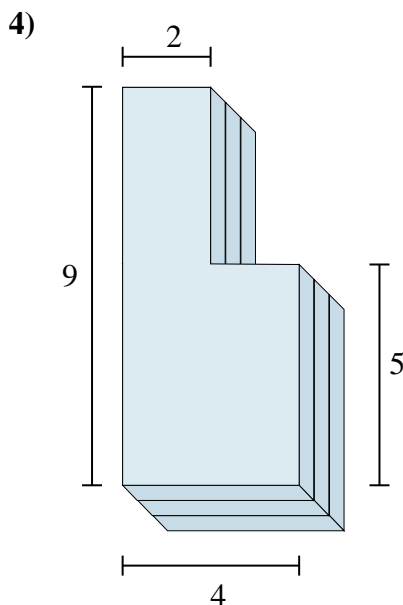
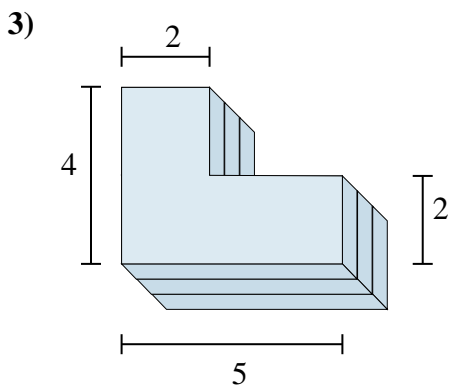
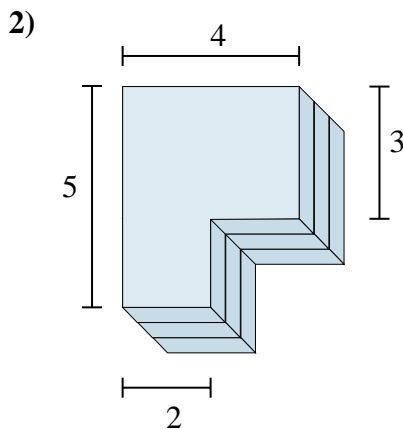
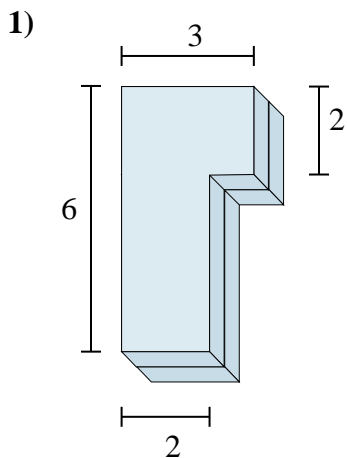

Answers

1. **28 cm<sup>3</sup>**

2. **48 cm<sup>3</sup>**

3. **42 cm<sup>3</sup>**

4. **84 cm<sup>3</sup>**

5. **62 cm<sup>3</sup>**

6. **30 cm<sup>3</sup>**



Find the total volume of each figure shown. Measured in cm (not to scale).

Answers

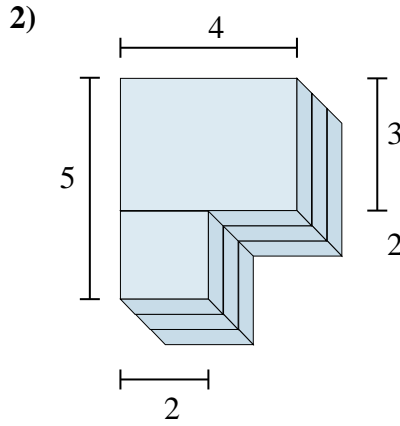
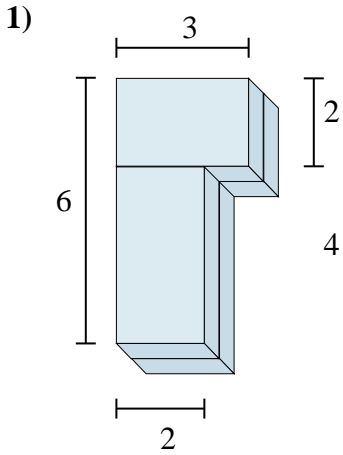

1. \_\_\_\_\_

2. \_\_\_\_\_

3. \_\_\_\_\_

4. \_\_\_\_\_

5. \_\_\_\_\_

6. \_\_\_\_\_

