

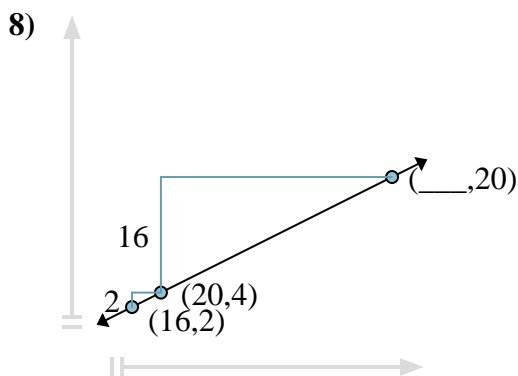

Find the missing coordinate in each problem.

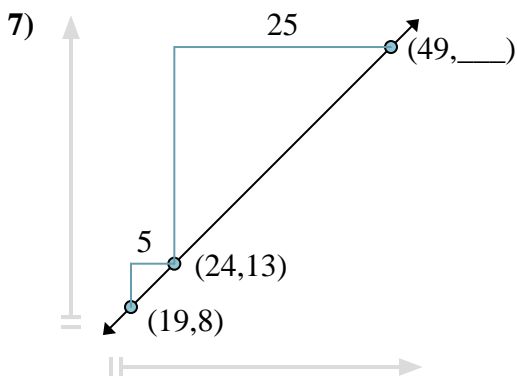
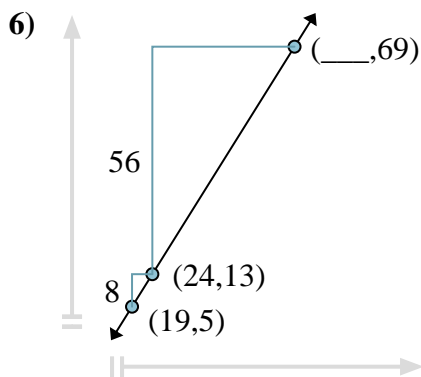
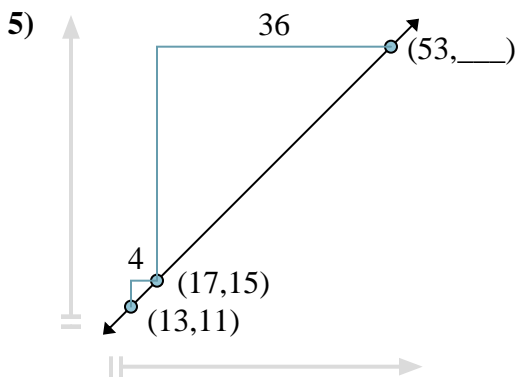
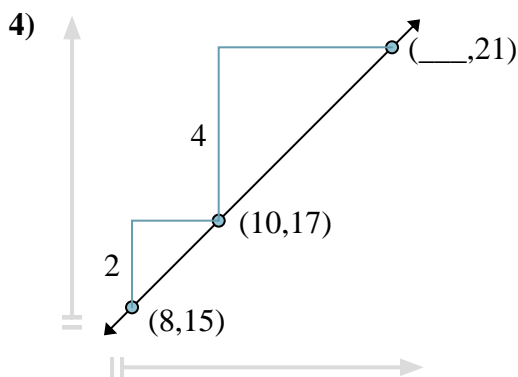
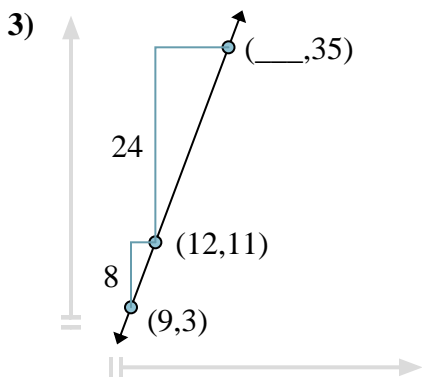
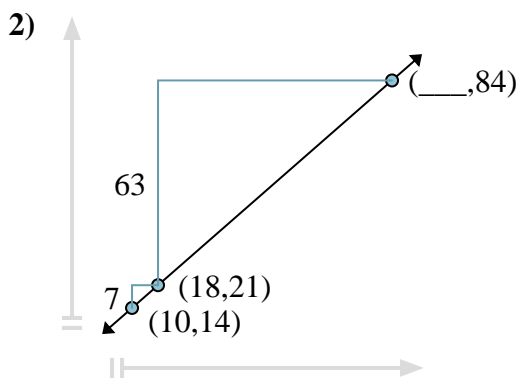
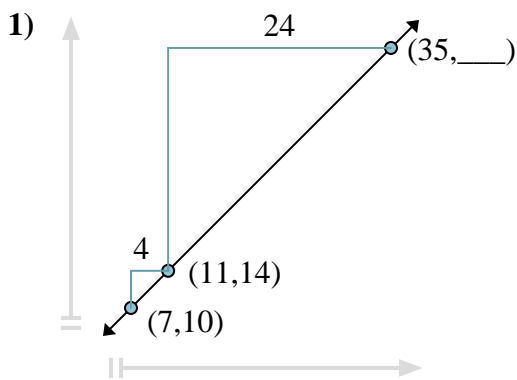

Answers

1. _____
2. _____
3. _____
4. _____
5. _____
6. _____
7. _____
8. _____



Find the missing coordinate in each problem.

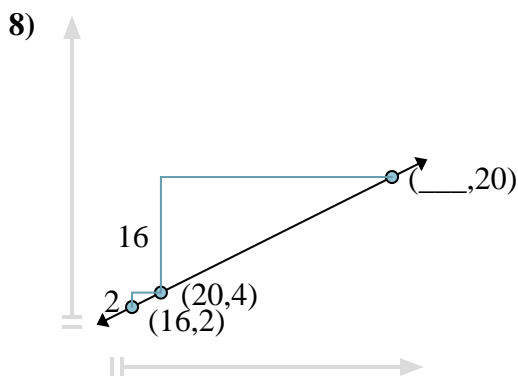
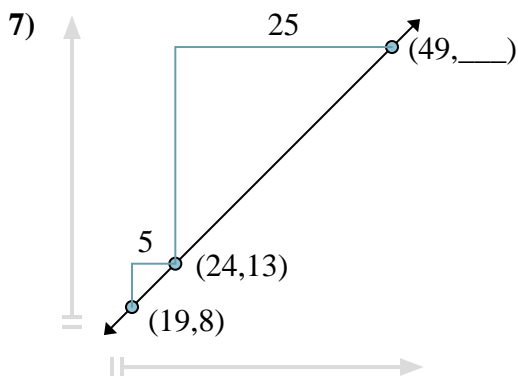
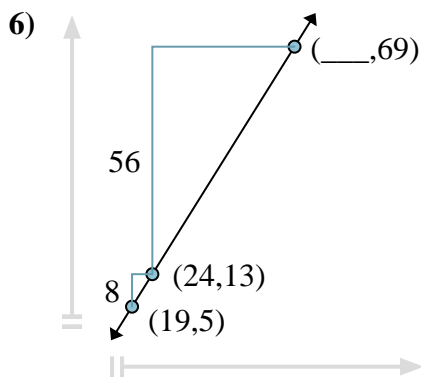
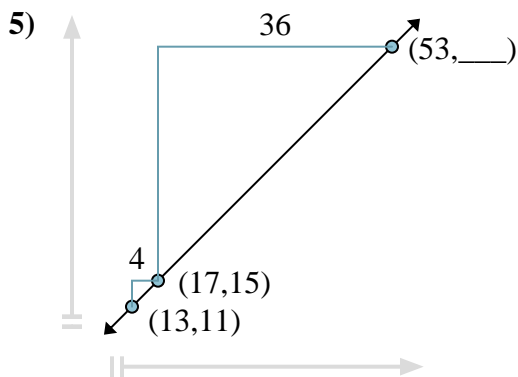
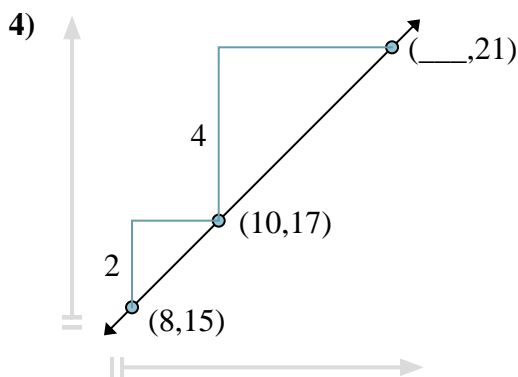
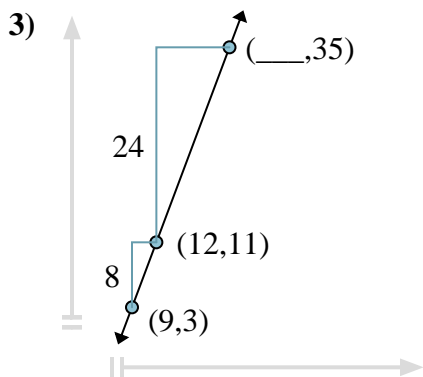
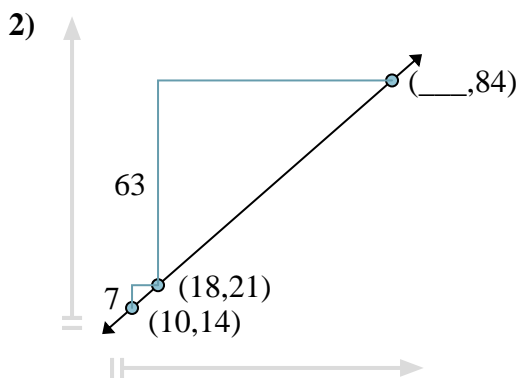
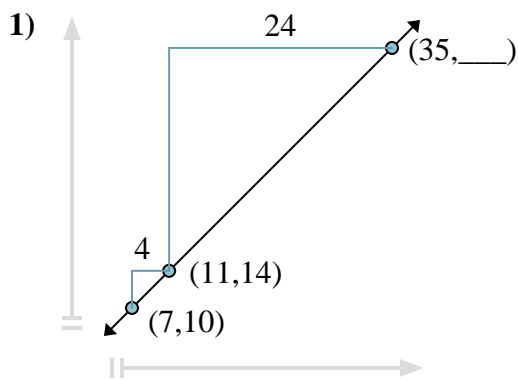

Answers

1. 38
2. 90
3. 21
4. 14
5. 51
6. 59
7. 38
8. 52



Find the missing coordinate in each problem.

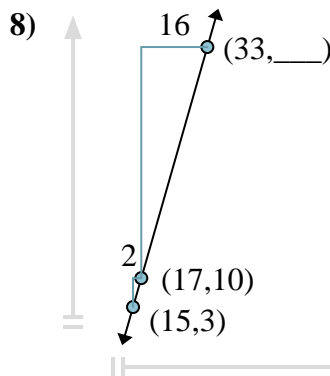
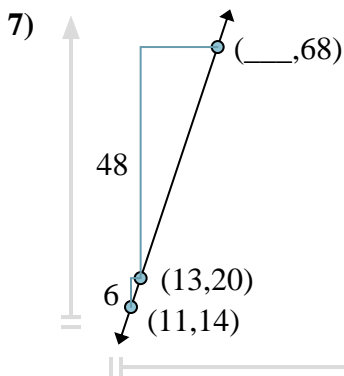
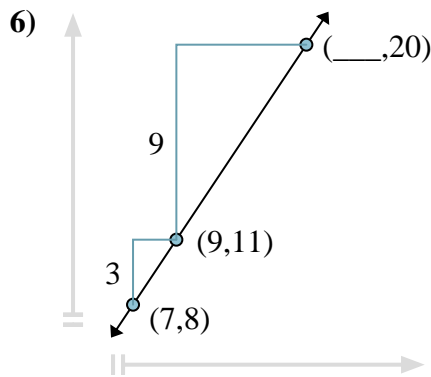
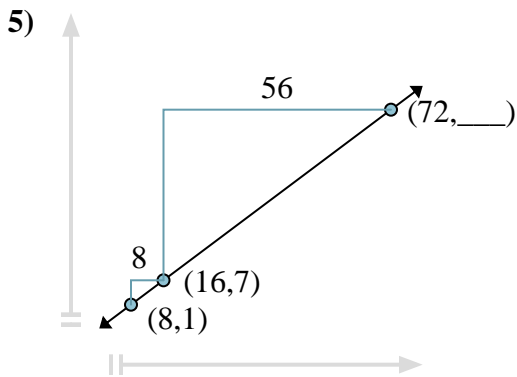
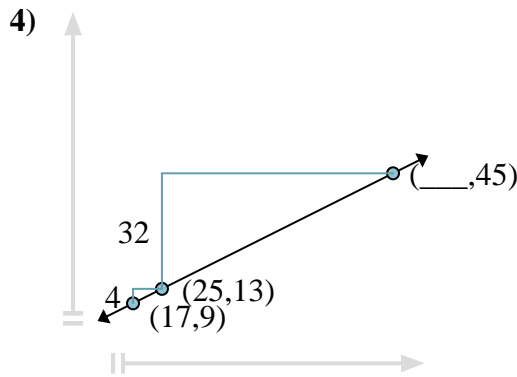
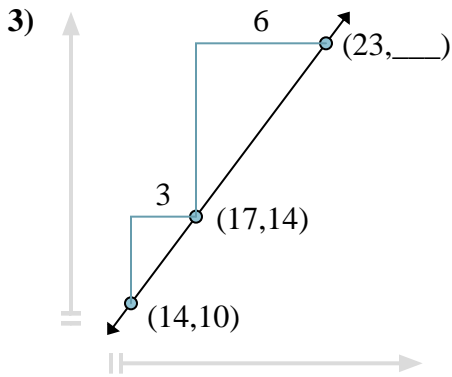
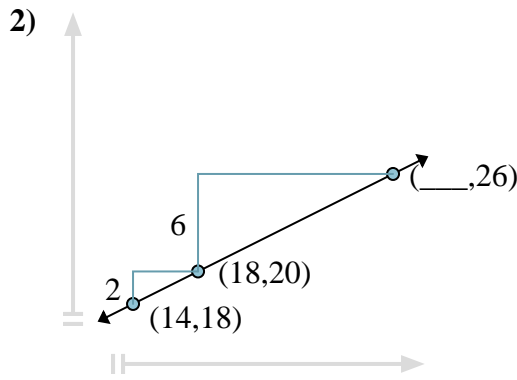
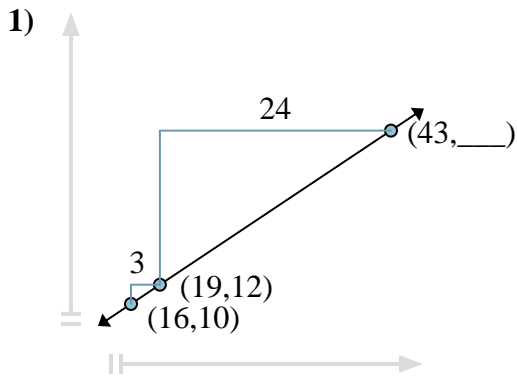

Answers

1. _____
2. _____
3. _____
4. _____
5. _____
6. _____
7. _____
8. _____



Find the missing coordinate in each problem.

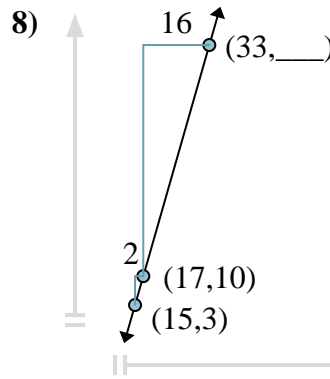
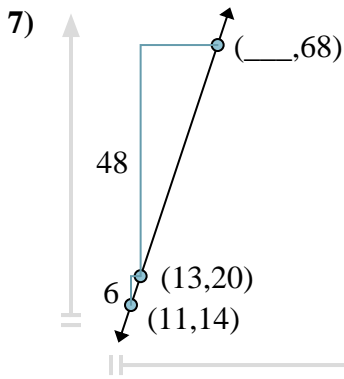
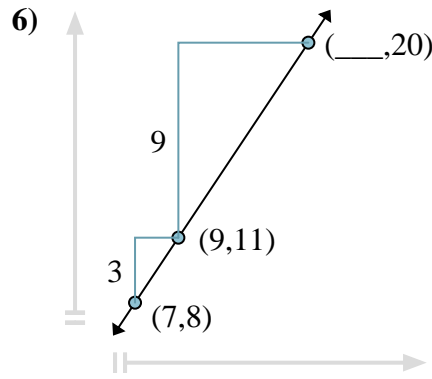
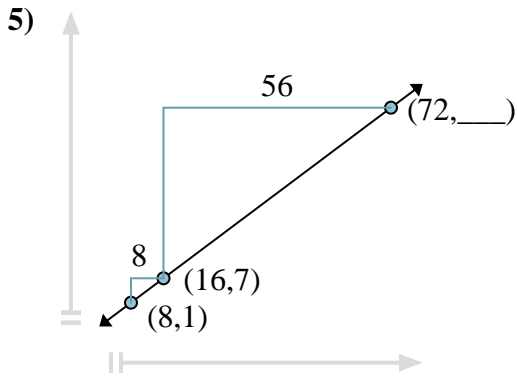
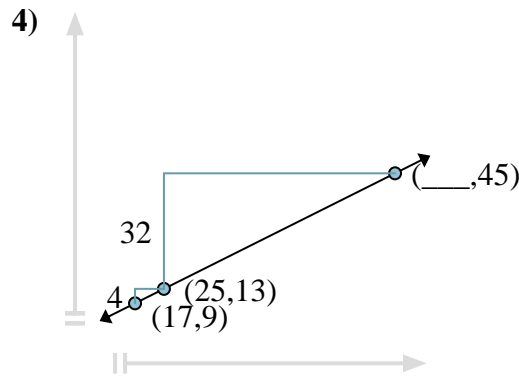
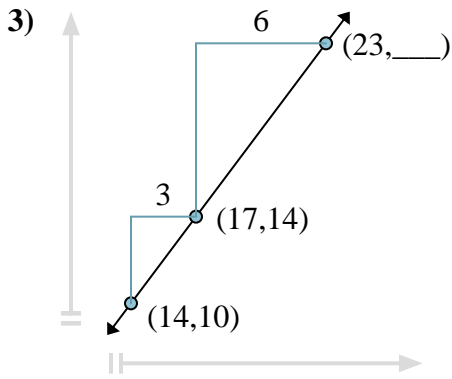
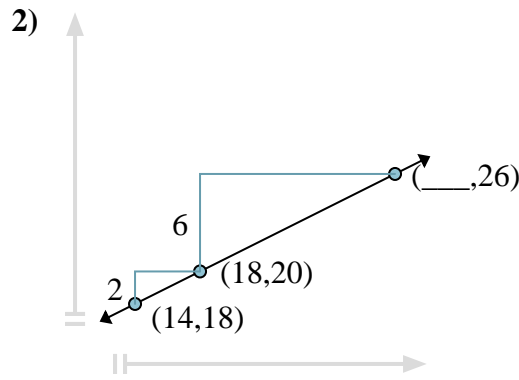
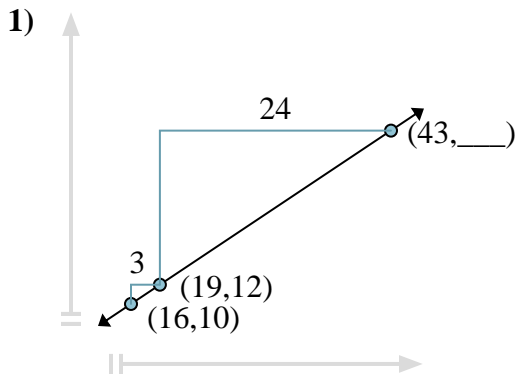

Answers

1. 28
2. 30
3. 22
4. 89
5. 49
6. 15
7. 29
8. 66



Find the missing coordinate in each problem.

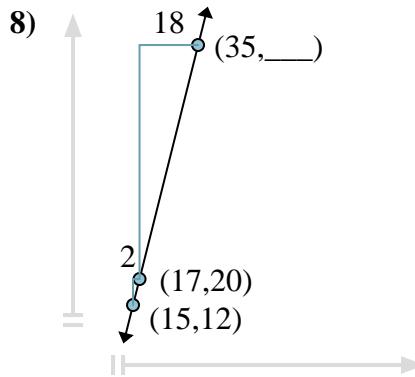
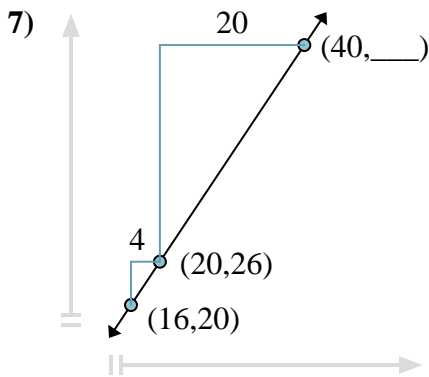
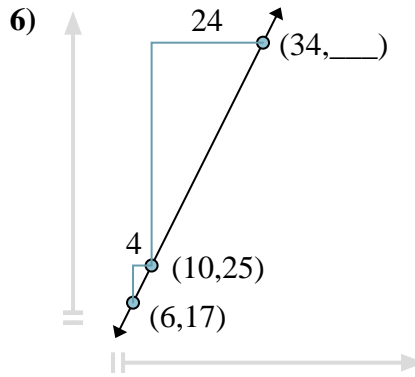
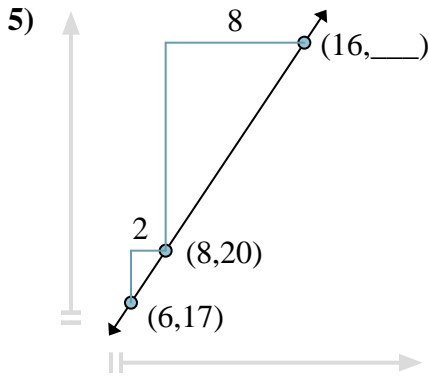
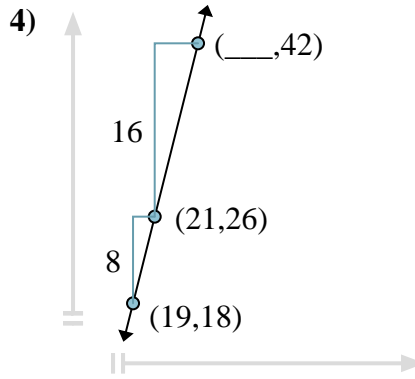
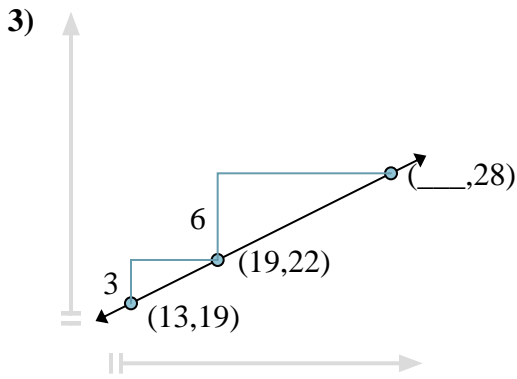
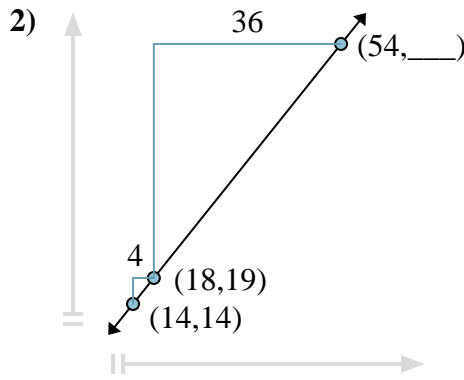
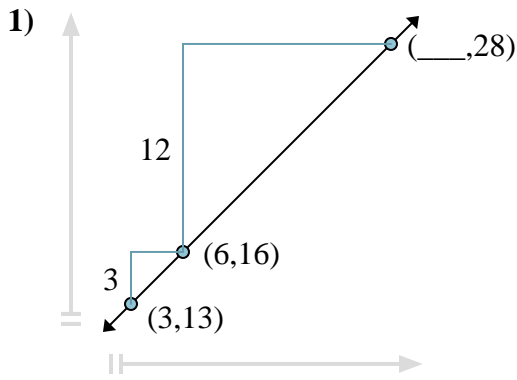

Answers

1. _____
2. _____
3. _____
4. _____
5. _____
6. _____
7. _____
8. _____



Find the missing coordinate in each problem.

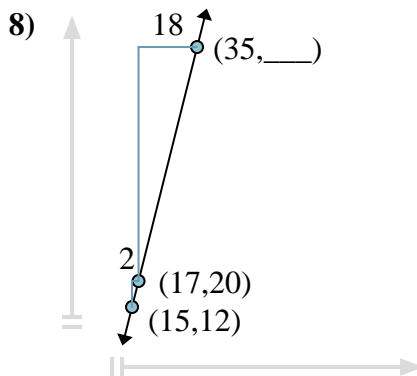
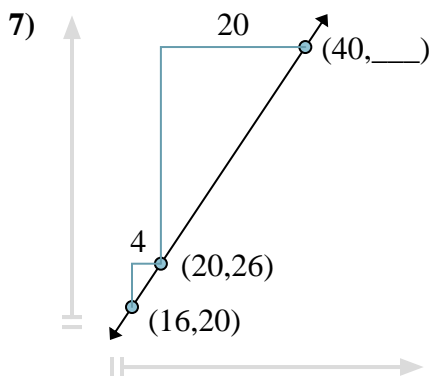
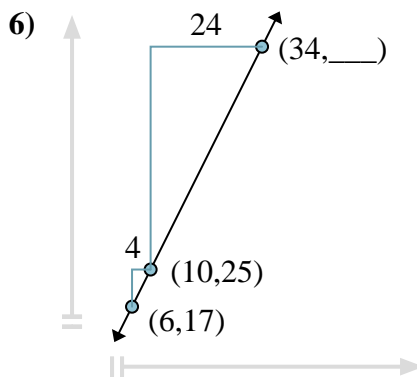
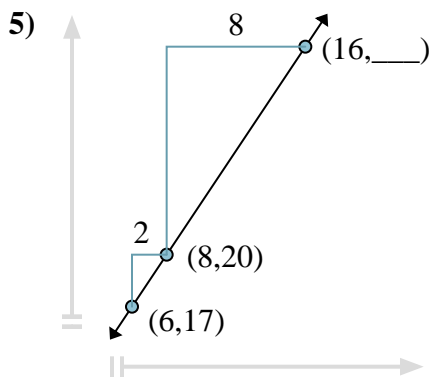
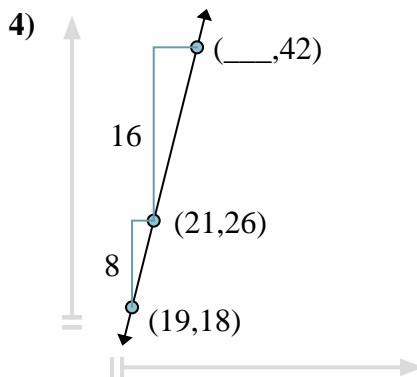
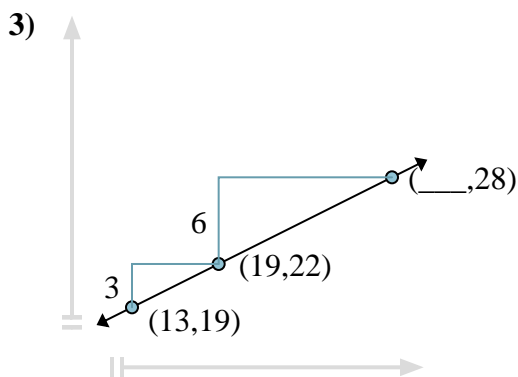
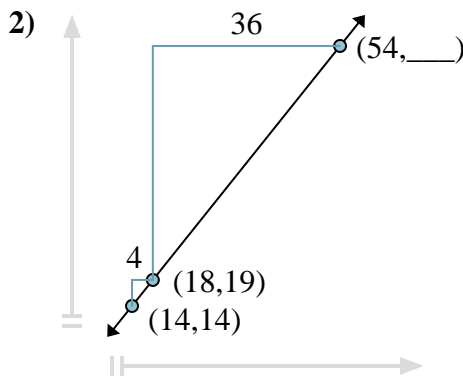
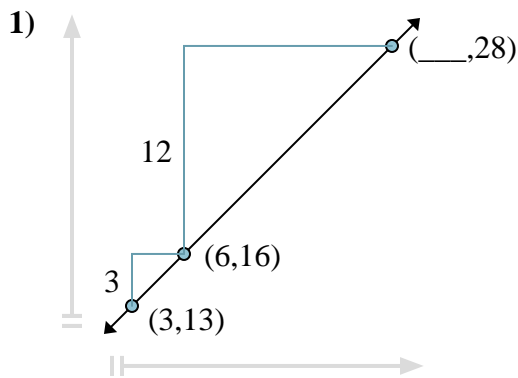

Answers

1. 18
2. 64
3. 31
4. 25
5. 32
6. 73
7. 56
8. 92



Find the missing coordinate in each problem.

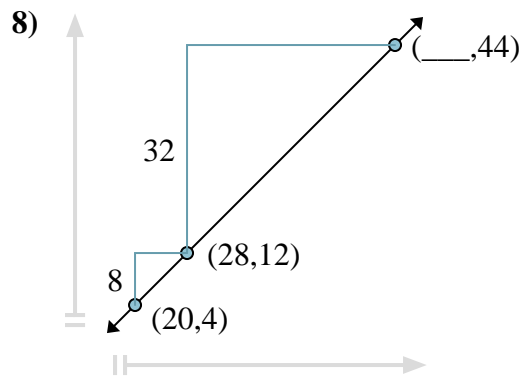
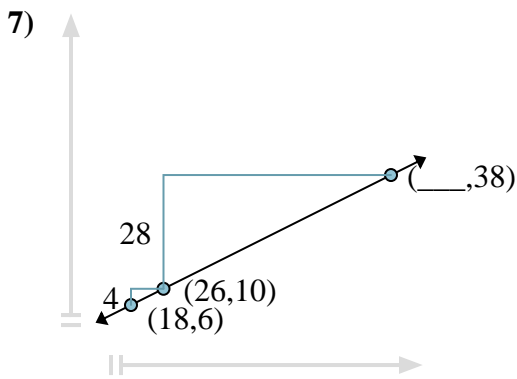
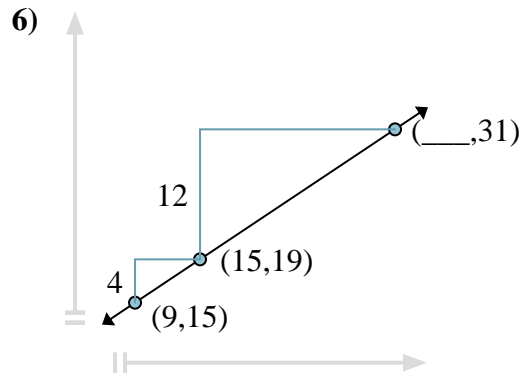
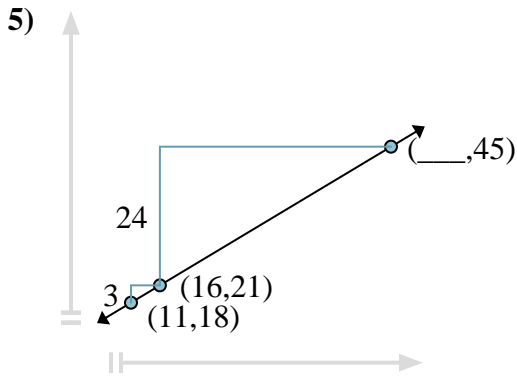
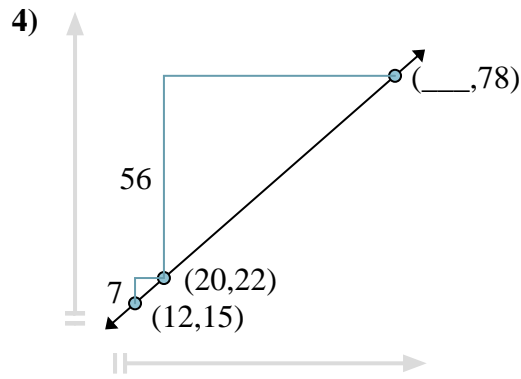
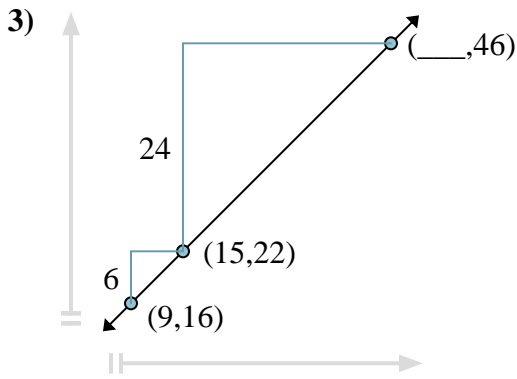
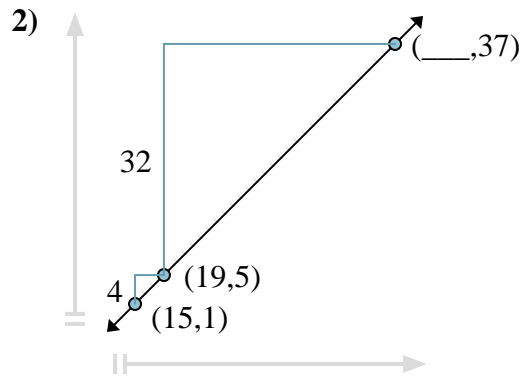
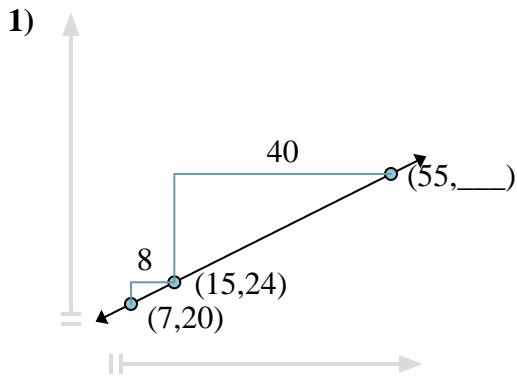

Answers

1. _____
2. _____
3. _____
4. _____
5. _____
6. _____
7. _____
8. _____



Find the missing coordinate in each problem.

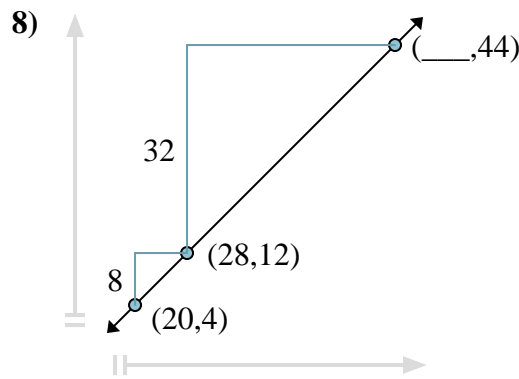
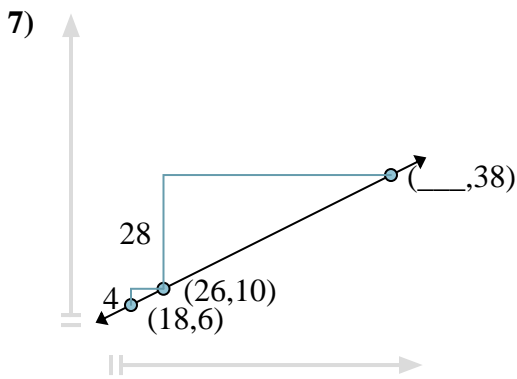
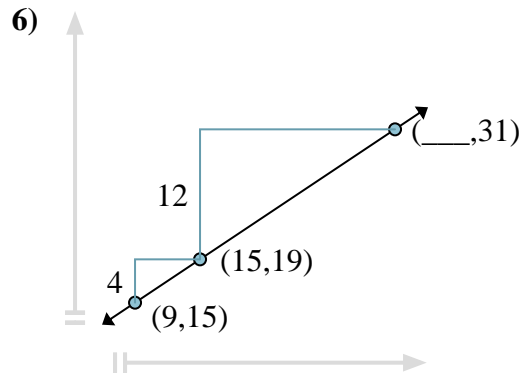
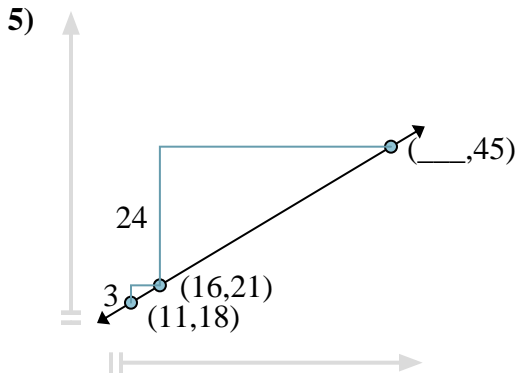
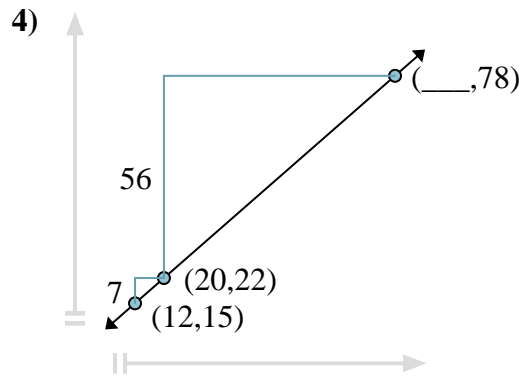
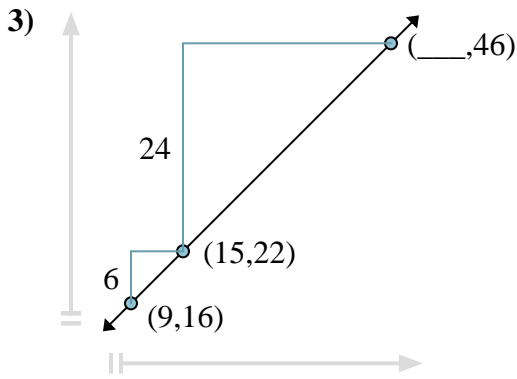
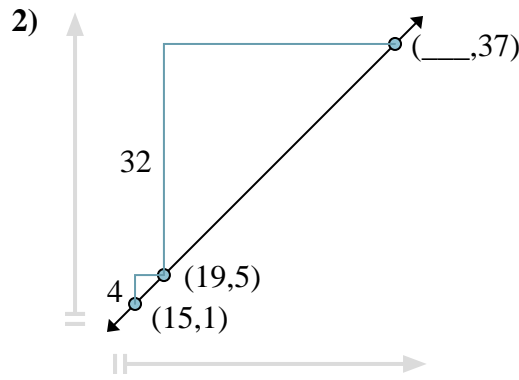
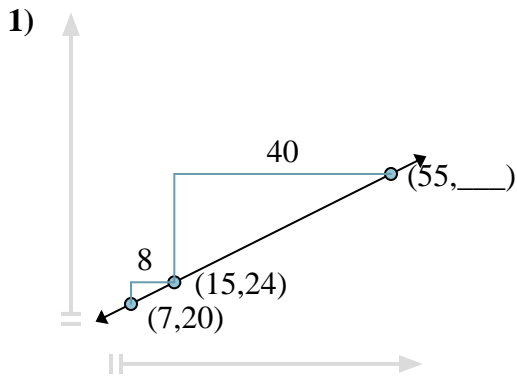

Answers

1. 44
2. 51
3. 39
4. 84
5. 56
6. 33
7. 82
8. 60



Find the missing coordinate in each problem.

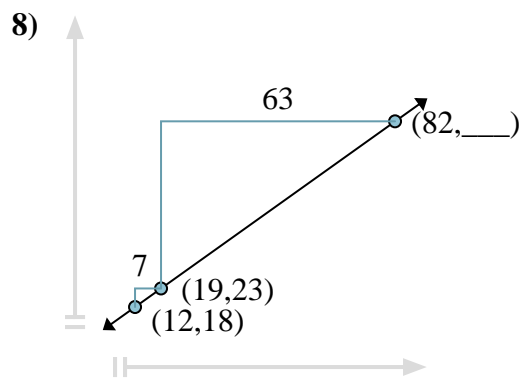
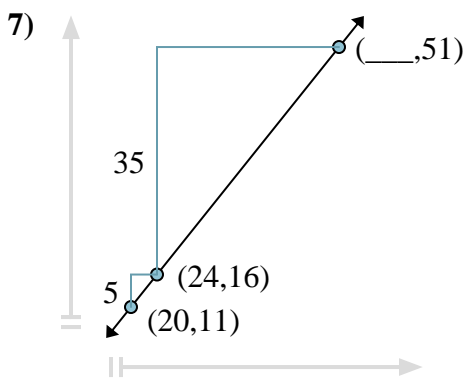
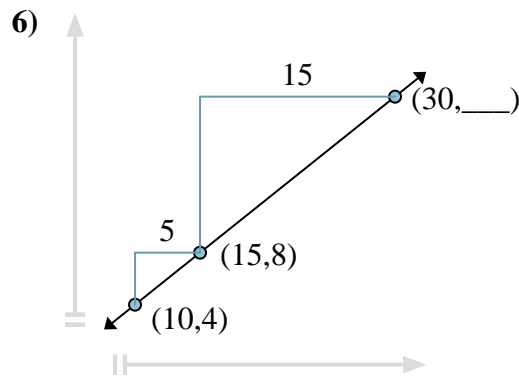
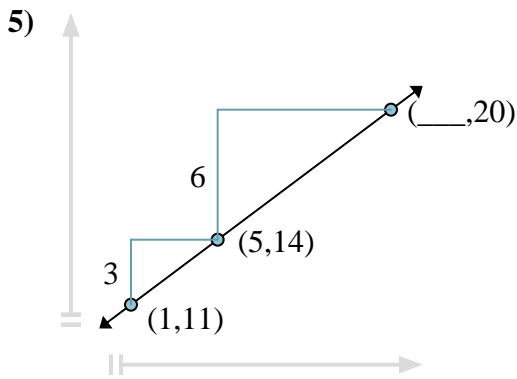
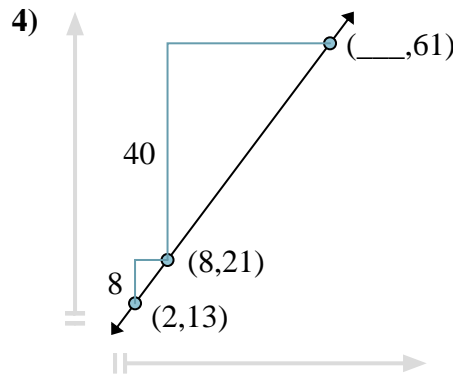
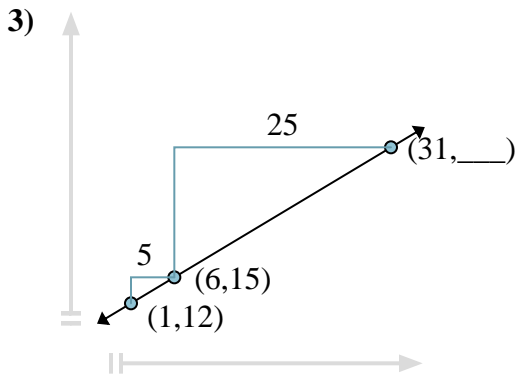
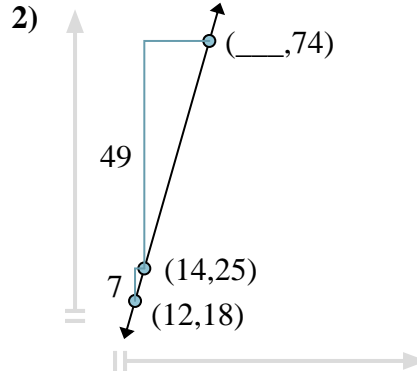
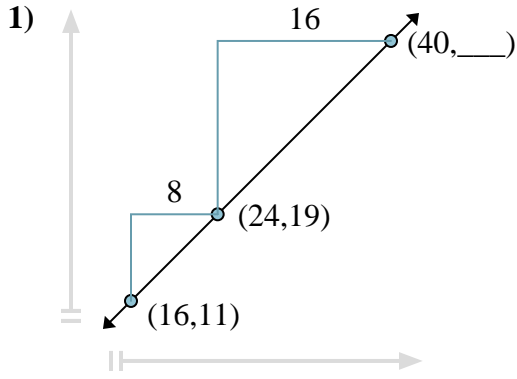

Answers

1. _____
2. _____
3. _____
4. _____
5. _____
6. _____
7. _____
8. _____



Find the missing coordinate in each problem.

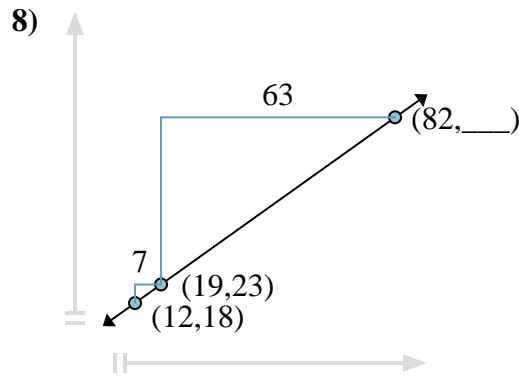
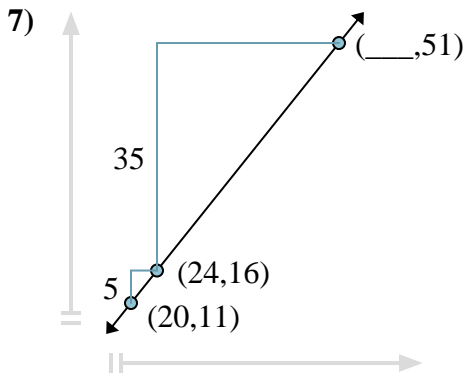
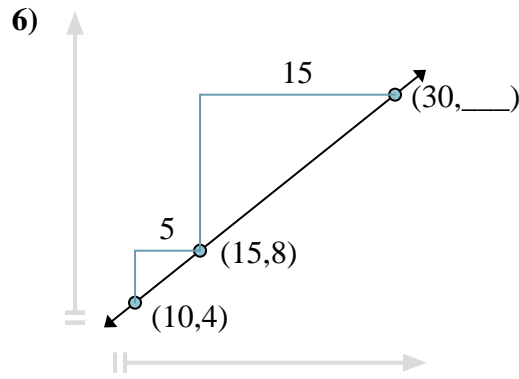
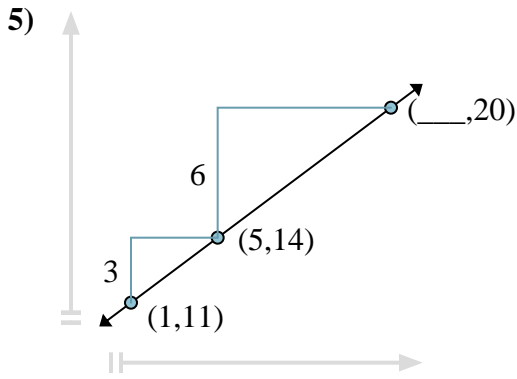
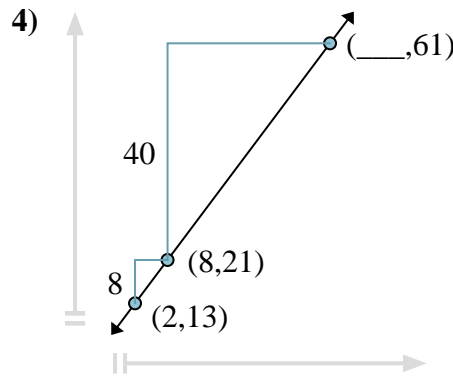
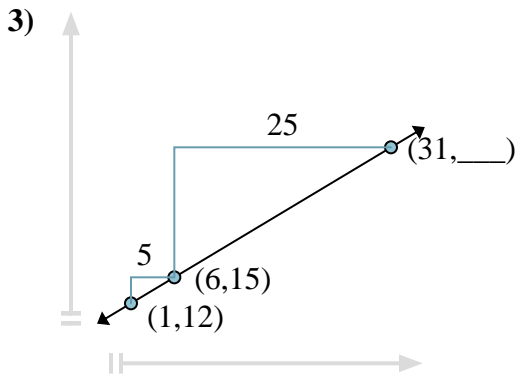
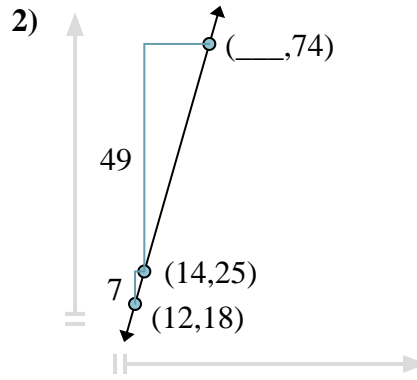
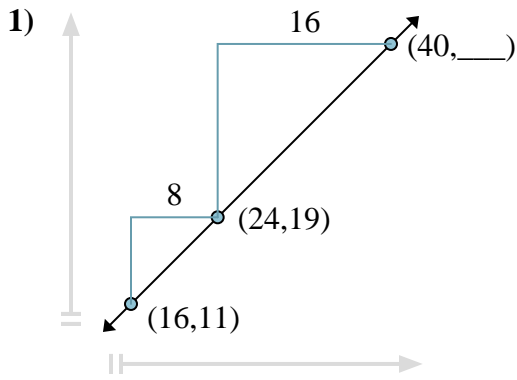

Answers

1. 35
2. 28
3. 30
4. 38
5. 13
6. 20
7. 52
8. 68



Find the missing coordinate in each problem.

Answers

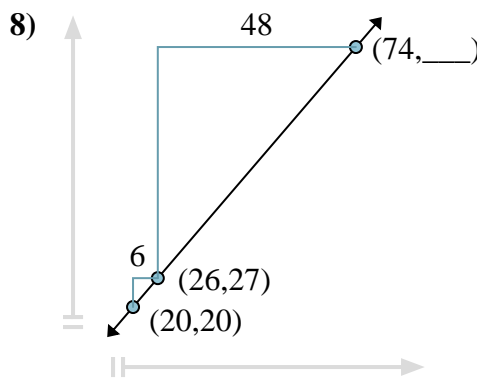
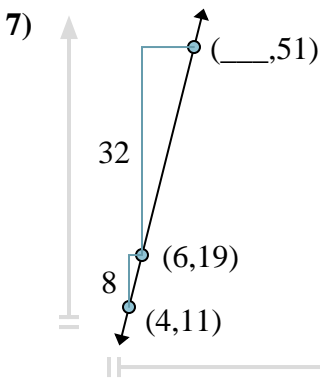
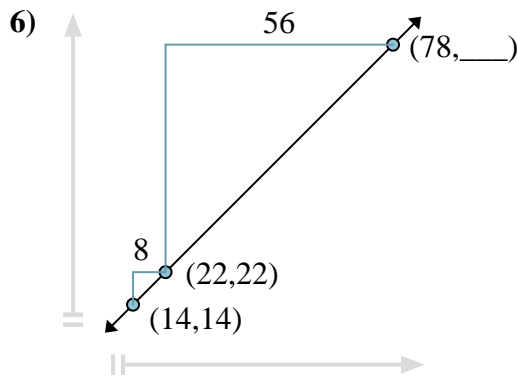
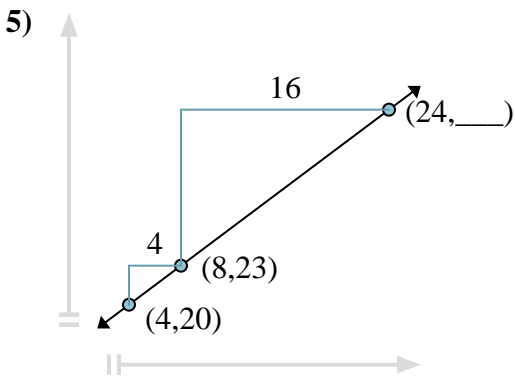
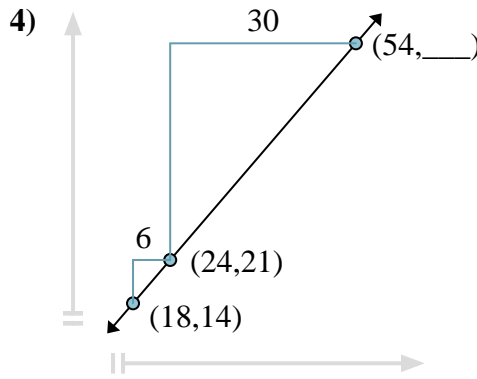
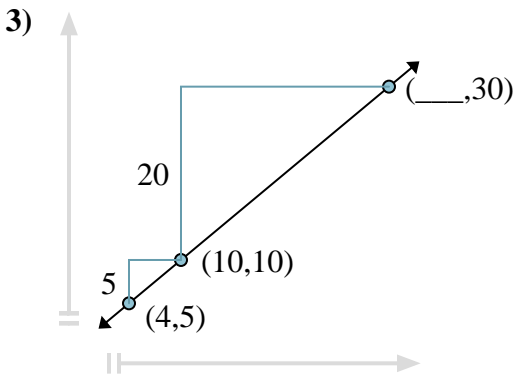
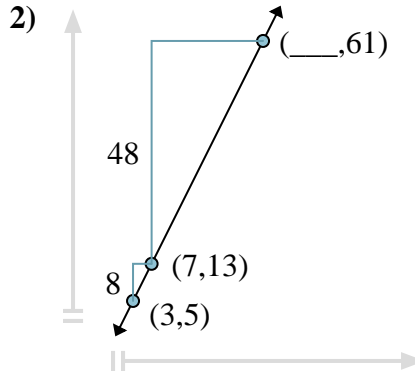
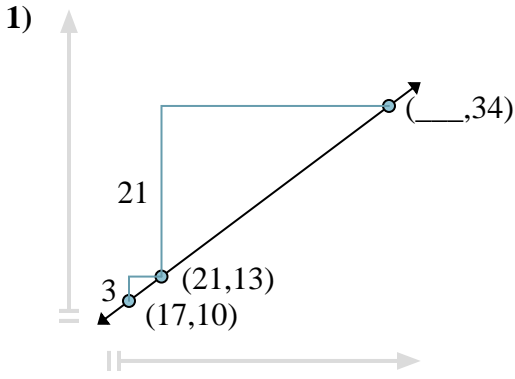

1. _____
2. _____
3. _____
4. _____
5. _____
6. _____
7. _____
8. _____



Find the missing coordinate in each problem.

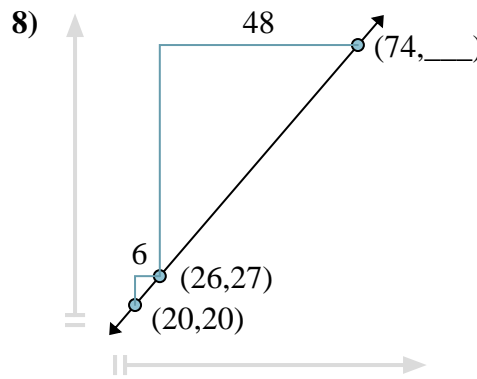
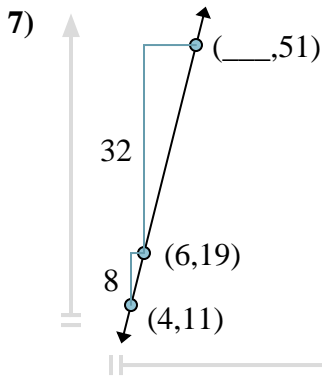
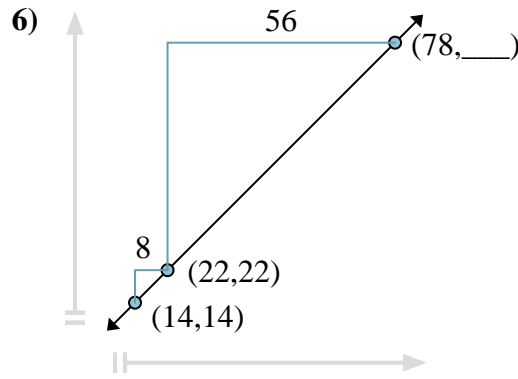
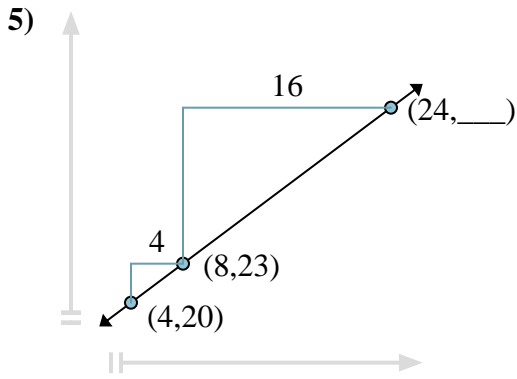
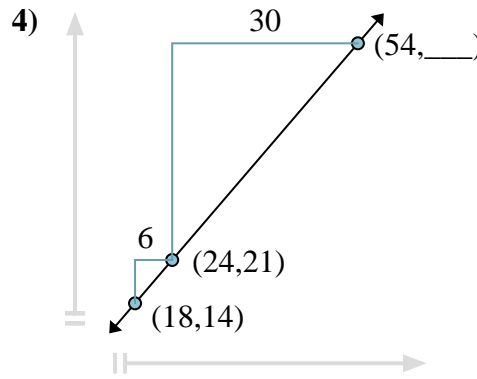
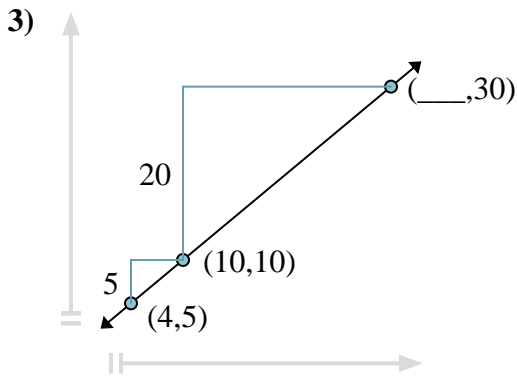
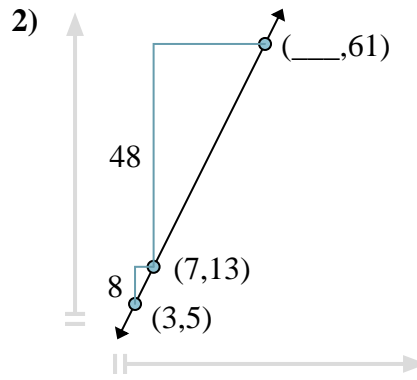
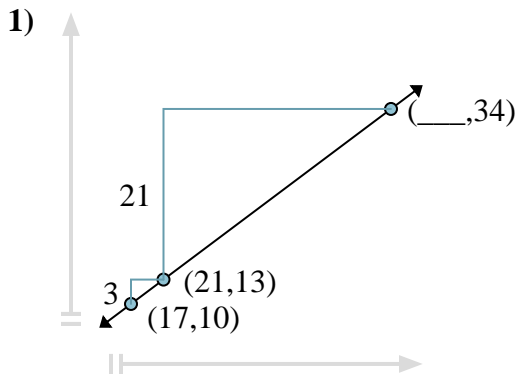

Answers

1. 49
2. 31
3. 34
4. 56
5. 35
6. 78
7. 14
8. 83



Find the missing coordinate in each problem.

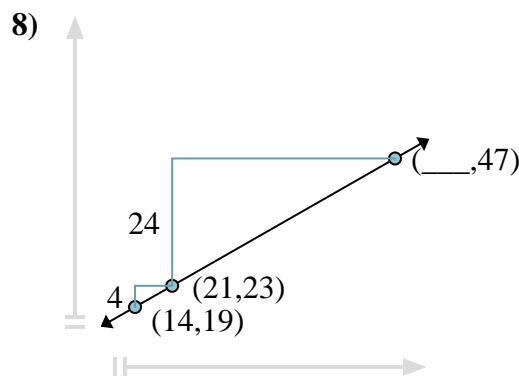
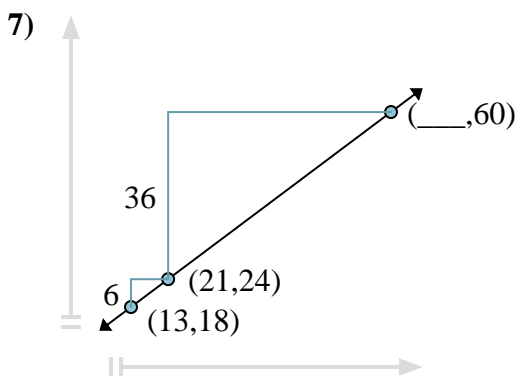
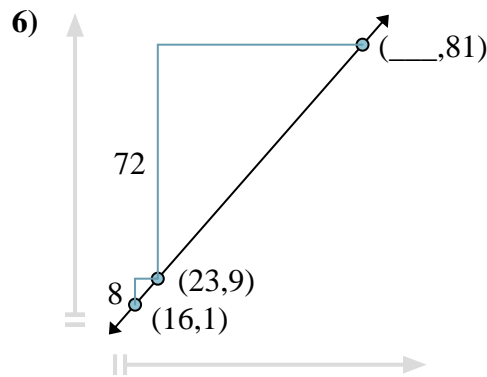
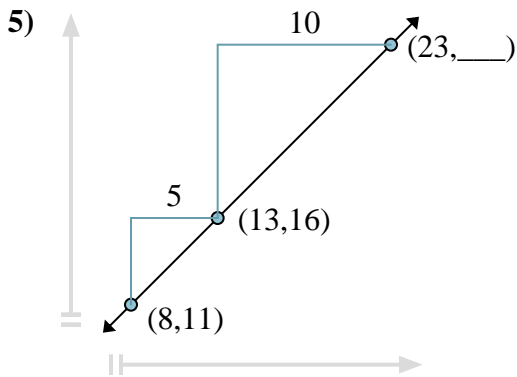
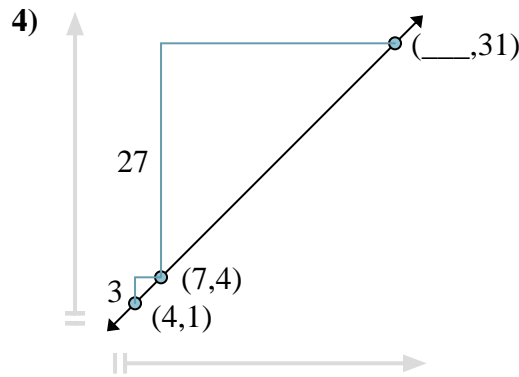
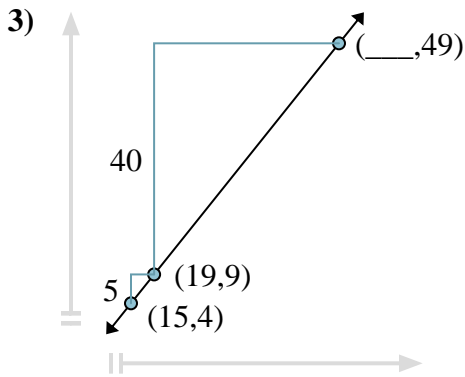
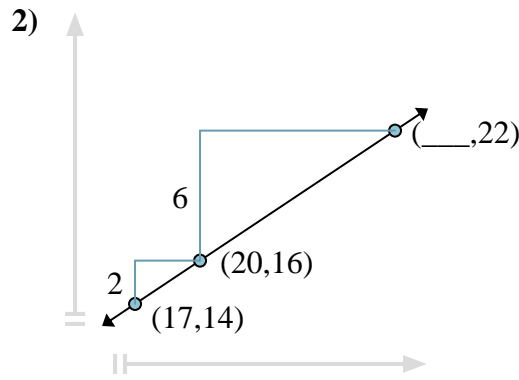
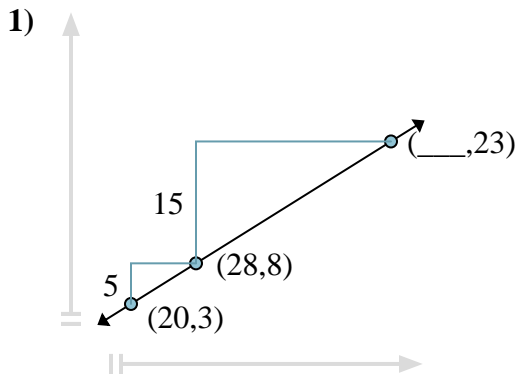

Answers

1. _____
2. _____
3. _____
4. _____
5. _____
6. _____
7. _____
8. _____



Find the missing coordinate in each problem.

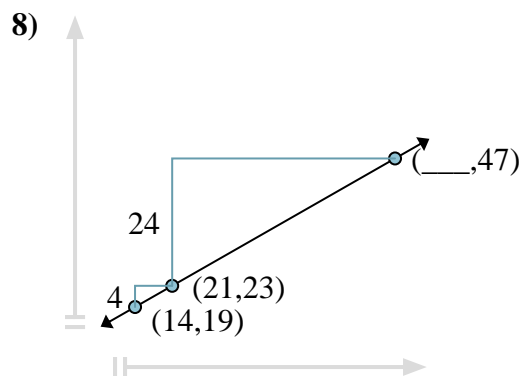
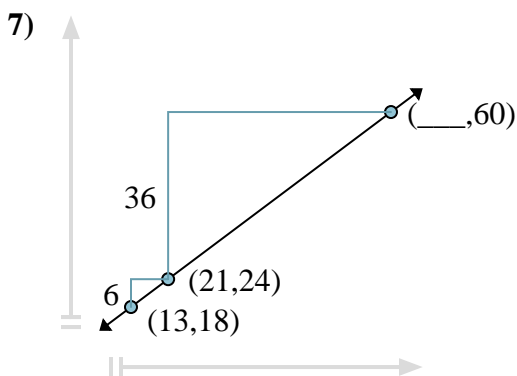
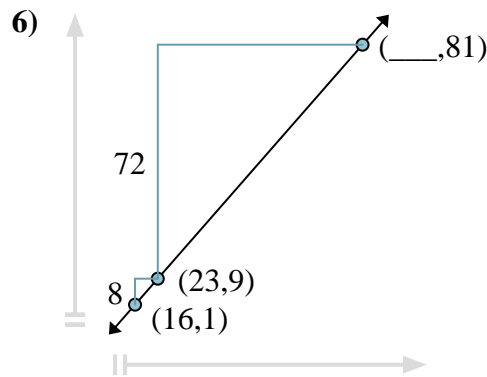
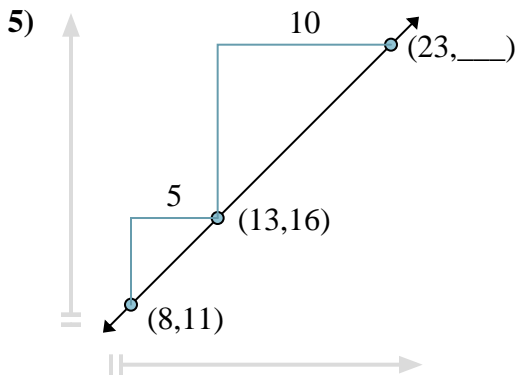
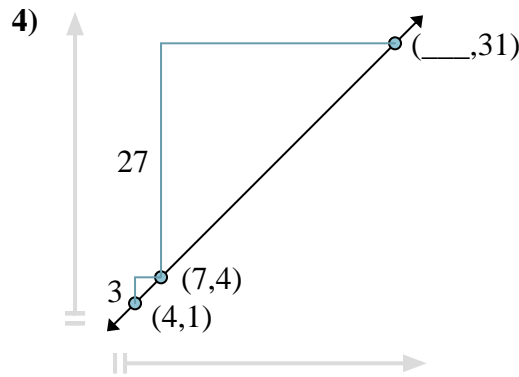
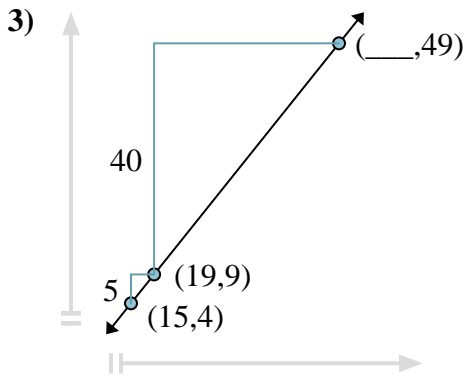
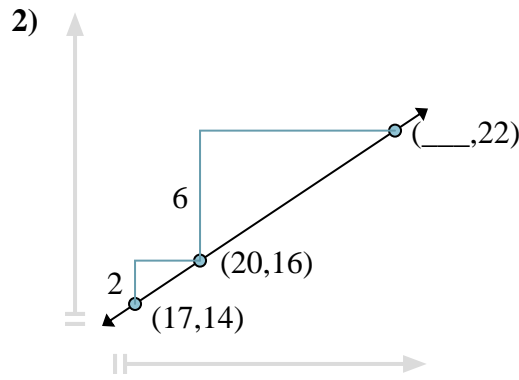
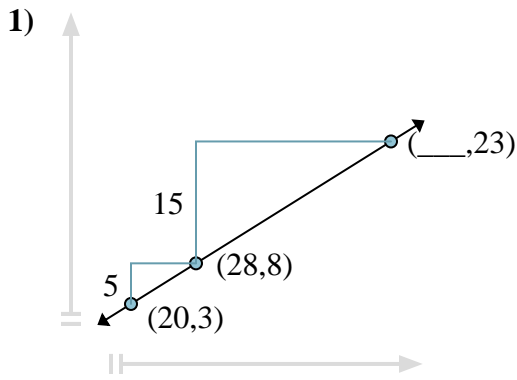

Answers

1. 52
2. 29
3. 51
4. 34
5. 26
6. 86
7. 69
8. 63



Find the missing coordinate in each problem.

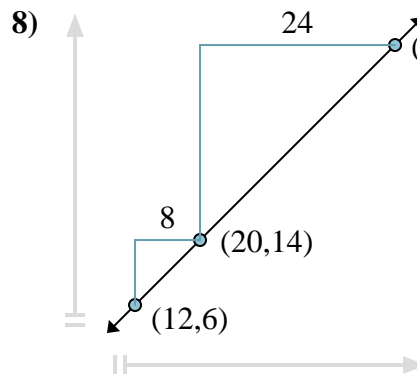
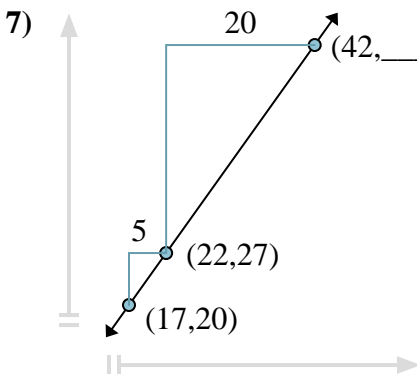
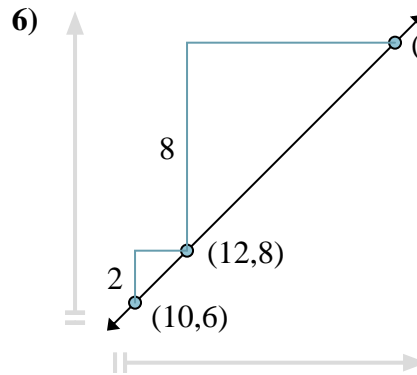
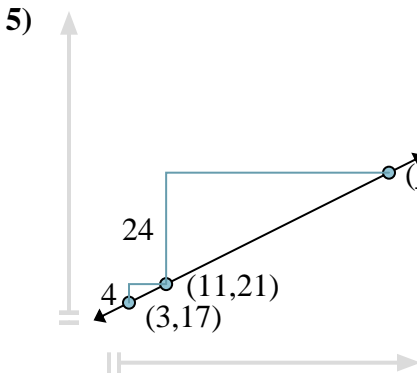
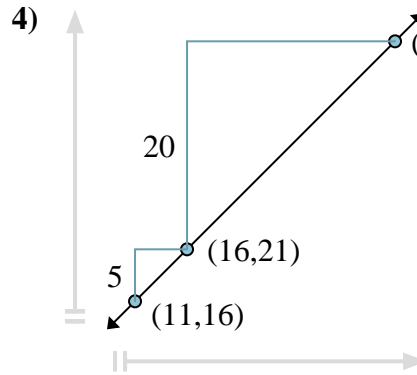
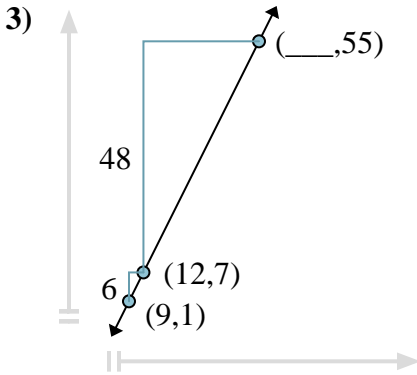
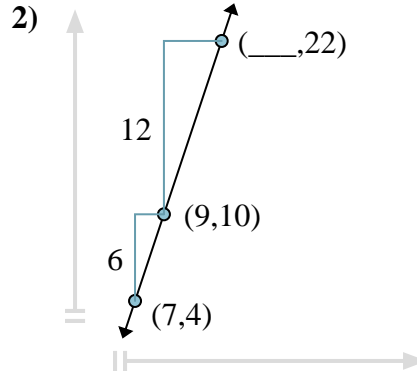
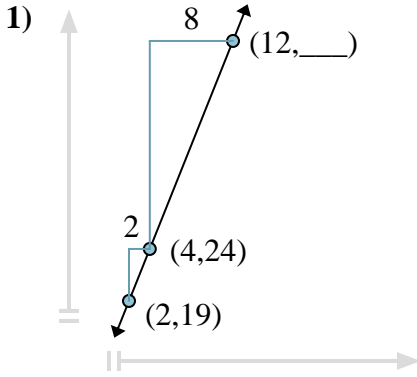

Answers

1. _____
2. _____
3. _____
4. _____
5. _____
6. _____
7. _____
8. _____



Find the missing coordinate in each problem.

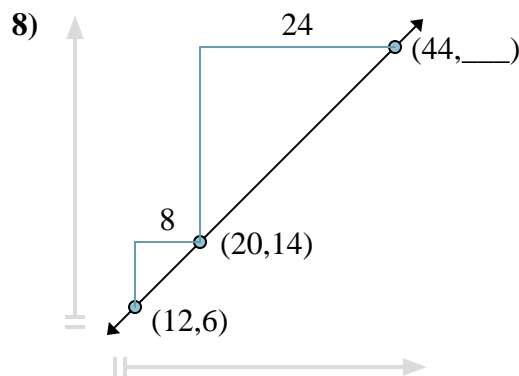
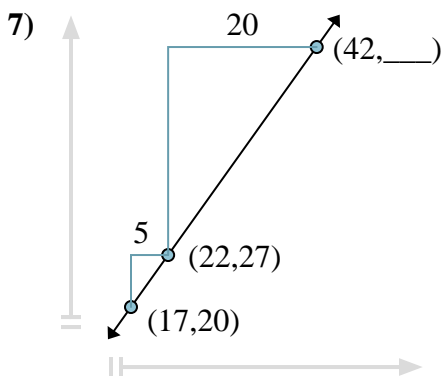
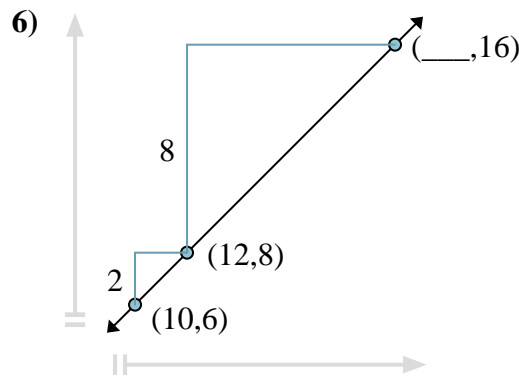
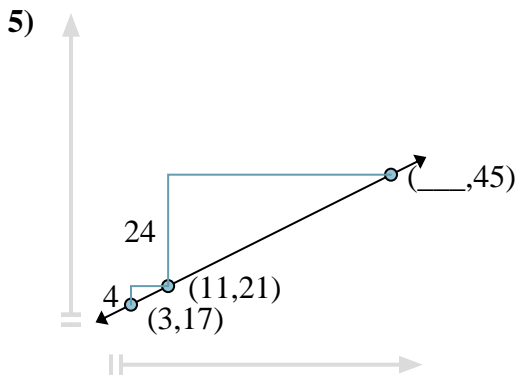
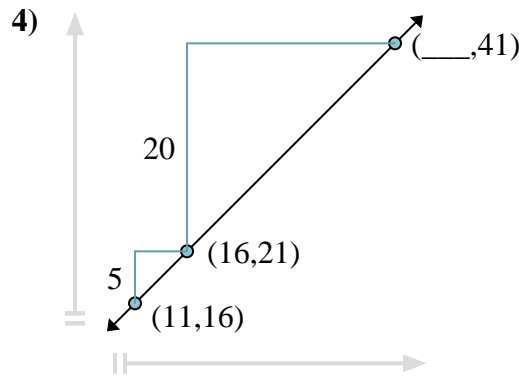
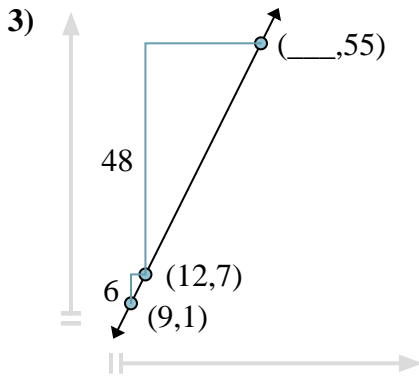
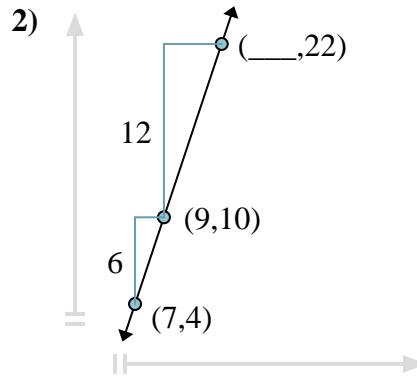
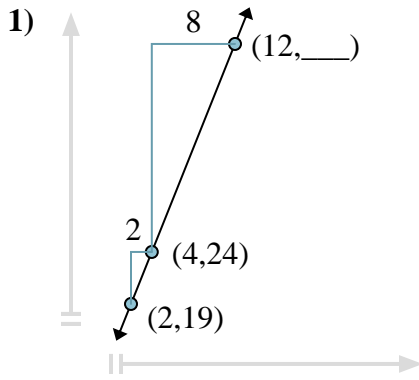

Answers

1. 44

2. 13

3. 36

4. 36

5. 59

6. 20

7. 55

8. 38



Find the missing coordinate in each problem.

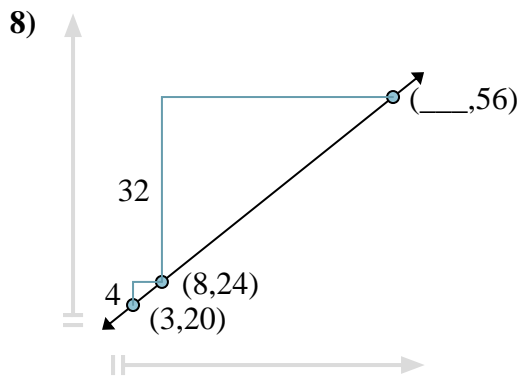
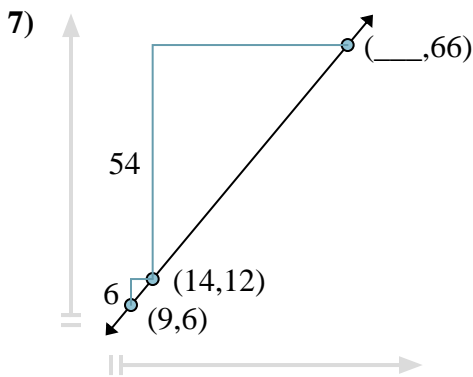
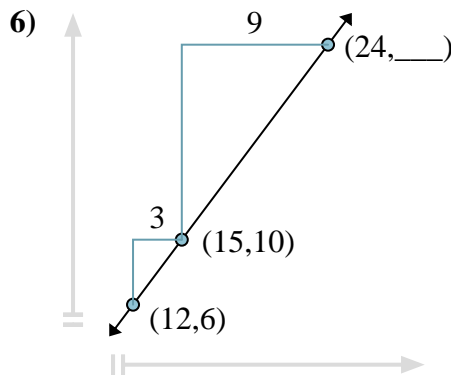
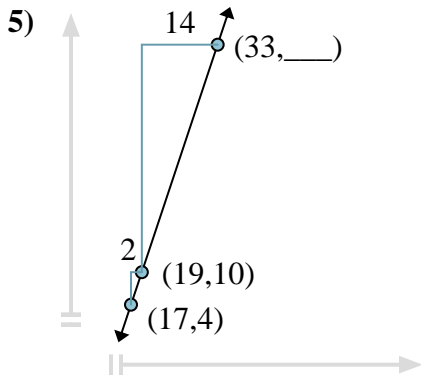
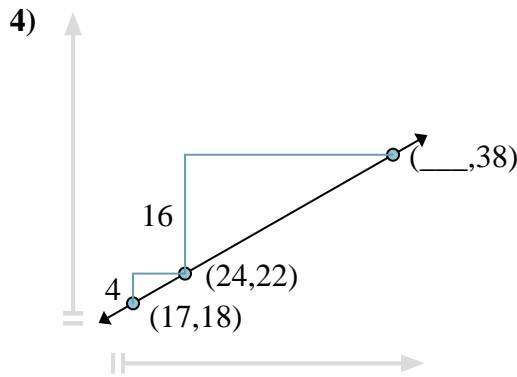
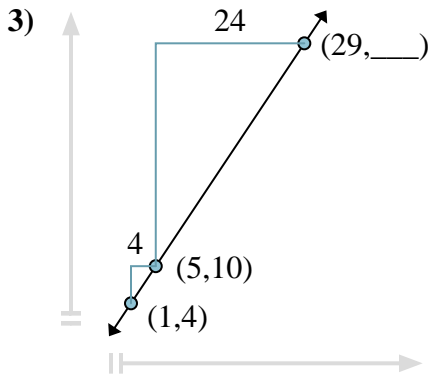
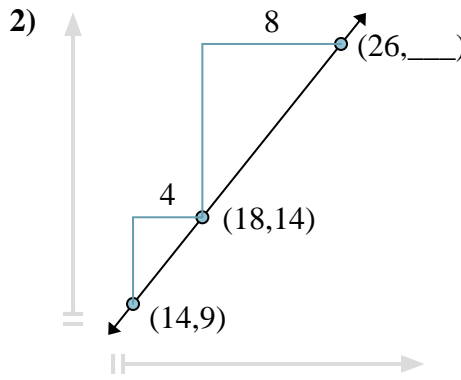
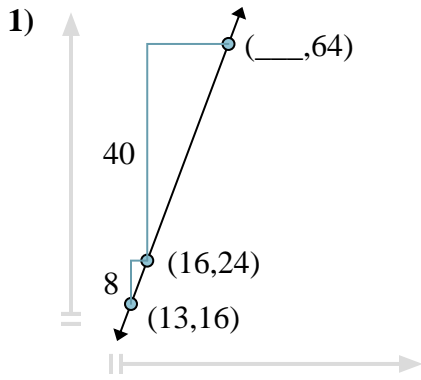

Answers

1. _____
2. _____
3. _____
4. _____
5. _____
6. _____
7. _____
8. _____



Find the missing coordinate in each problem.

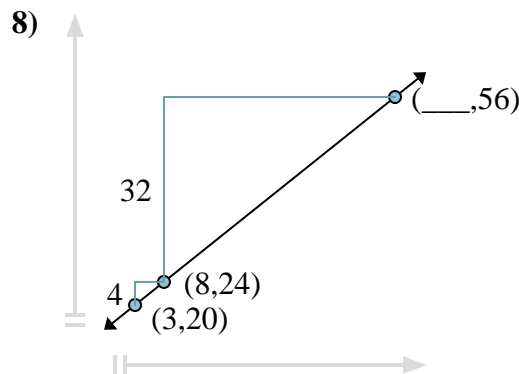
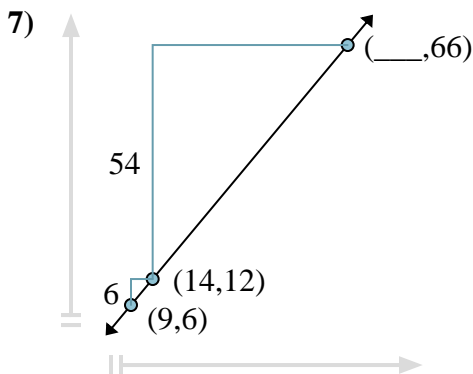
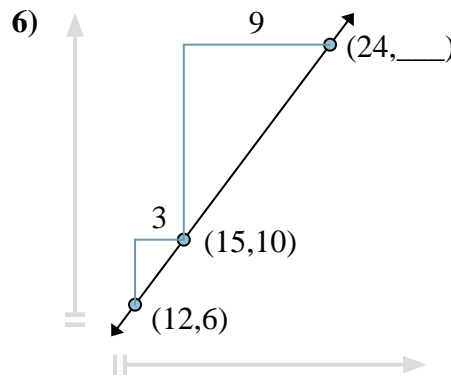
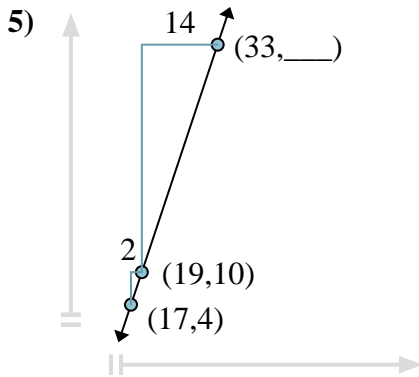
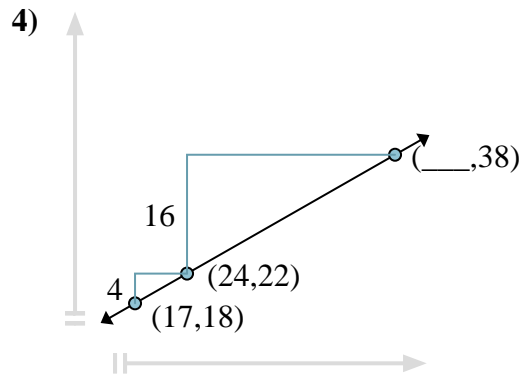
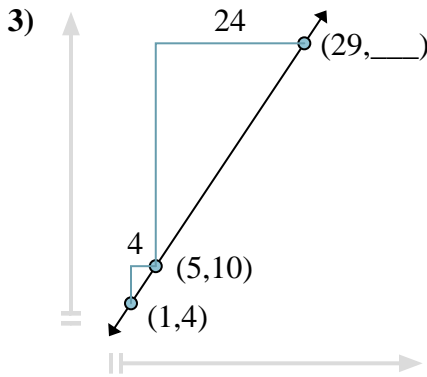
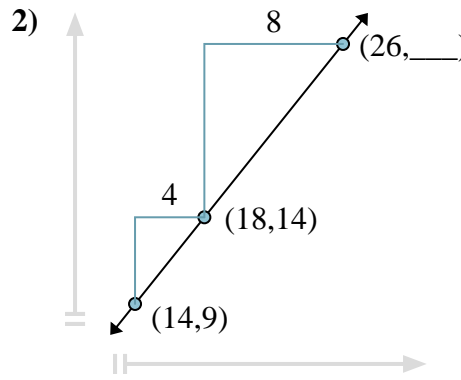
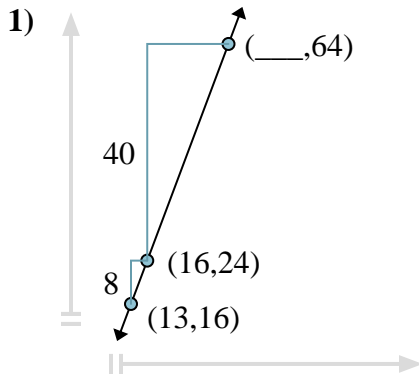

Answers

1. 31
2. 24
3. 46
4. 52
5. 52
6. 22
7. 59
8. 48



Find the missing coordinate in each problem.

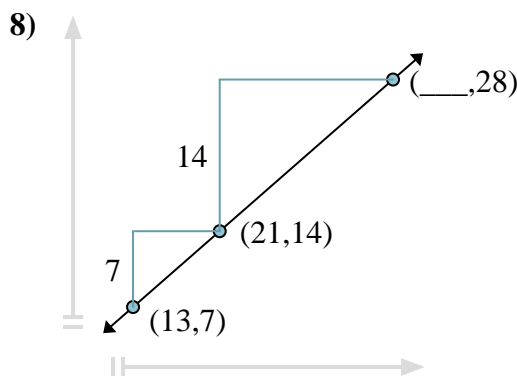
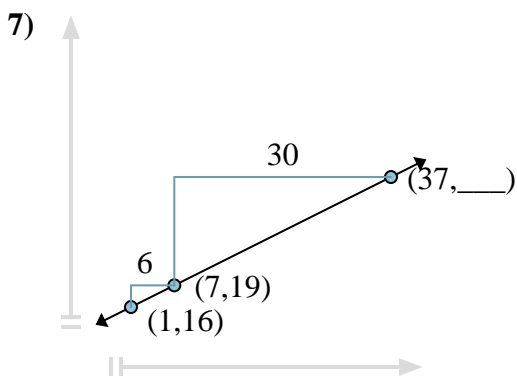
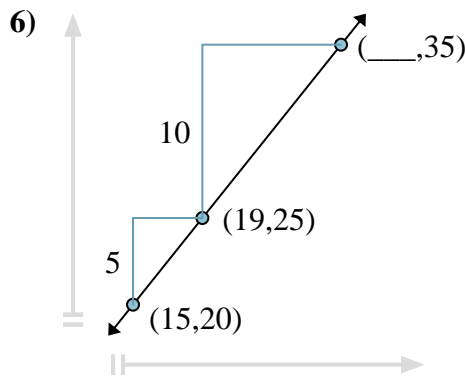
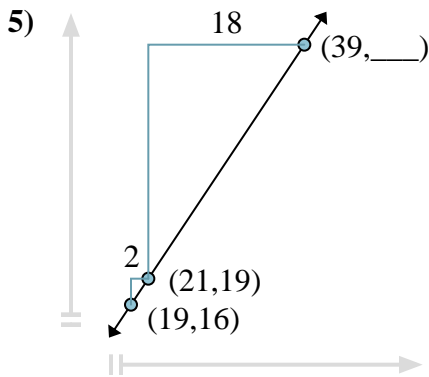
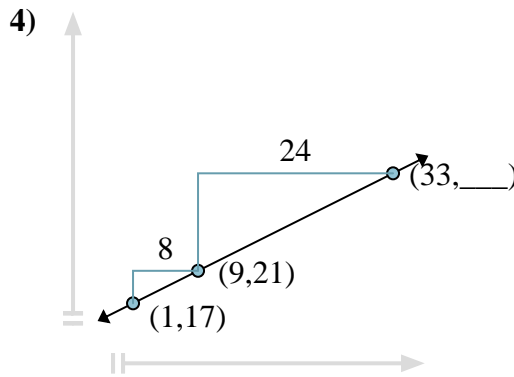
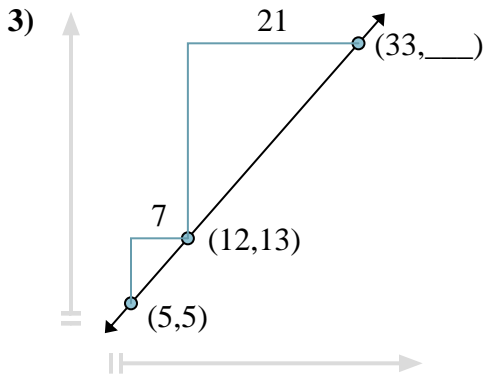
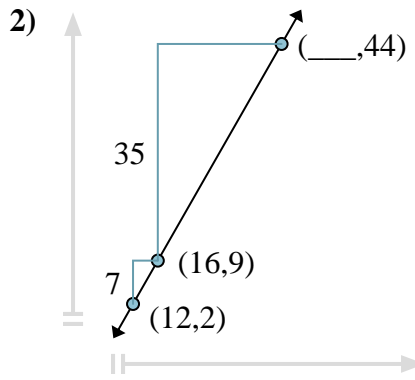
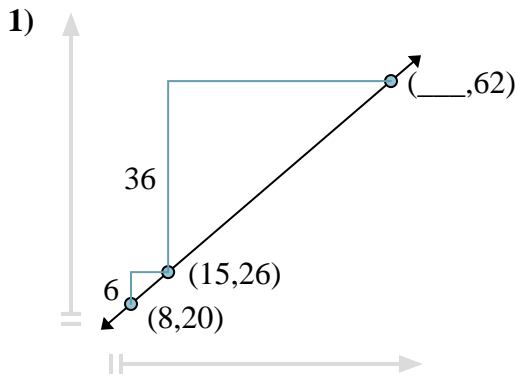

Answers

1. _____
2. _____
3. _____
4. _____
5. _____
6. _____
7. _____
8. _____



Find the missing coordinate in each problem.

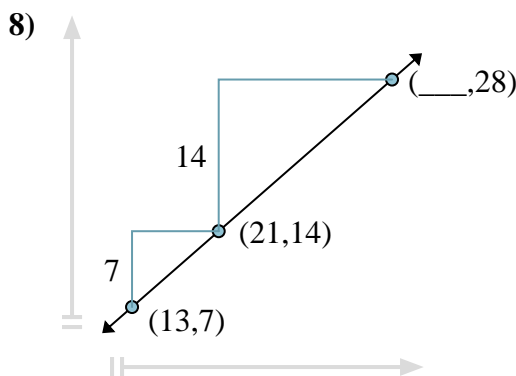
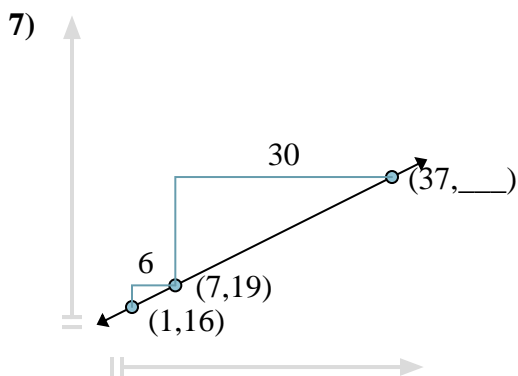
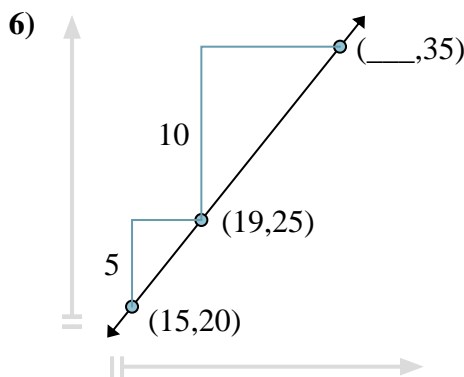
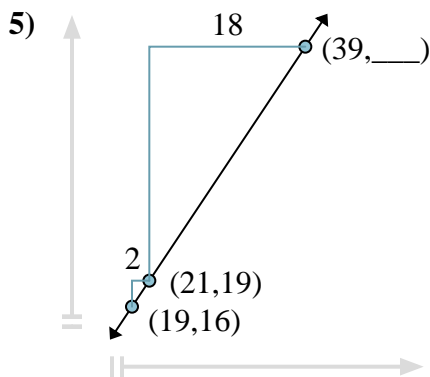
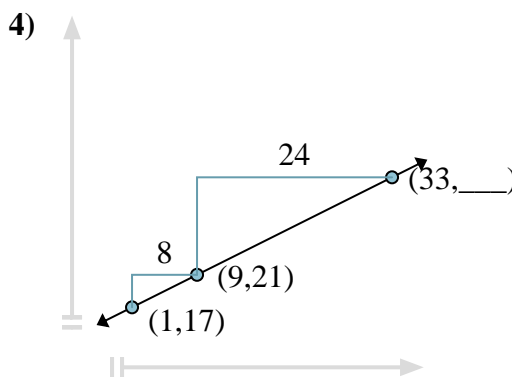
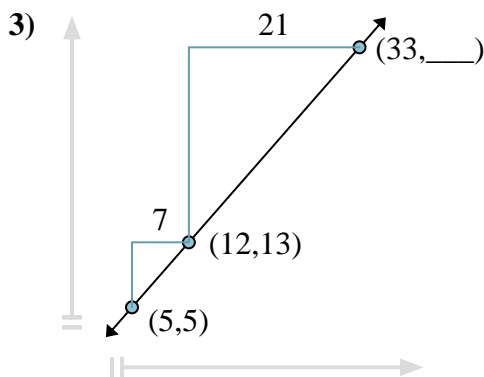
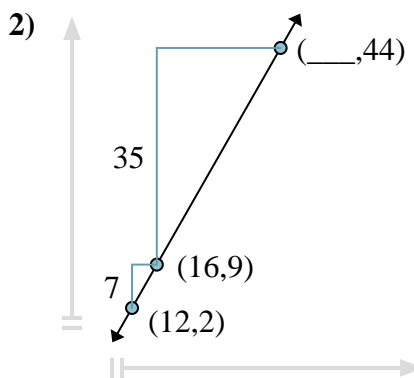
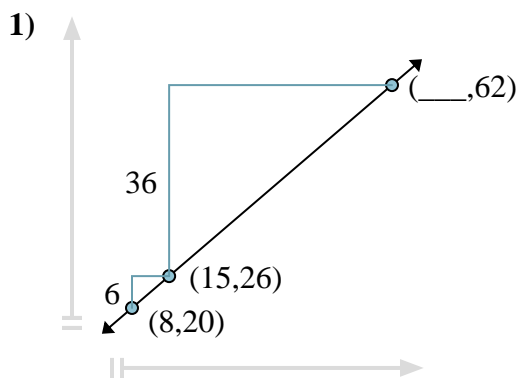

Answers

1. 57
2. 36
3. 37
4. 33
5. 46
6. 27
7. 34
8. 37